

Universal Office Solutions

your complete office solution...



En Core

design ► supply ► deliver ► install

“One-piece plastic chairs changed the modern classroom - we believe the one-piece plastic table will be the next advancement in school classroom design”

en core



en core table

One piece plastic table

en core can be stacked for storage, is easily transportable, durable, lightweight and 100% recyclable. The en core table can be used in multiple environments from classrooms to cafeterias and even exam halls.

The table can offer you the flexibility for adaptable settings with the use of the en core connected.

Our en one chair is used all over the world. The en core was developed to compliment the existing chair in design, strength and durability.

Available in 6 heights to accompany the innovative en one piece plastic chair. Custom colours available subject to MOQ.



100kg

Tested to and supports 100kg weight safely



Compliant

EN1729 parts 1 & 2



100% recyclable

We care for the environment and are always innovating to try and help reduce our impact on the world. Manufactured in the UK out of polypropylene, it is 100% recyclable at end of life.

product material

we care for the environment and are always innovating to try and help reduce our impact on the world. Manufactured in the UK from polypropylene, it is 100% recyclable

en compliant

EN1729 parts 1 & 2

product options

- Offered in sizes 1 to 6
- Available in 2 standard colour options of Royal Blue & Night Grey
- We can produce bespoke colours to match your colour scheme. Subject to MOQ
- Need to connect the tables together? No problem, we have the clever en connected for that.
- We even have a handy trolley to help you manoeuvre your en core tables
- Pen tray inserts (optional)
- UV protection (optional)
- Anti-Microbial additive (optional)
- Tray storage (optional)

product features

- Stacks 14 high within a 2 metre space
- 6kg weight makes them easy to move
- Tested to over 100 kg weight
- en groove colour inserts
- Connector available to link tables together
- Easy to store or move on our table trolley
- Simple to clean making them Hygienic
- Made from 100% recyclable material





en core connected

Creating your ideal learning space

The en core table is designed to maximize the usable surface space while keeping the footprint small.

The table is multi-functional and can be used as a single, double, block or in rows

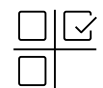

agile

Enabling schools to easily move, store and adopt varying classroom layouts depending on the lesson.



connected

Linking socket holds tables together securely. Easily removed. Available in 3 colours.

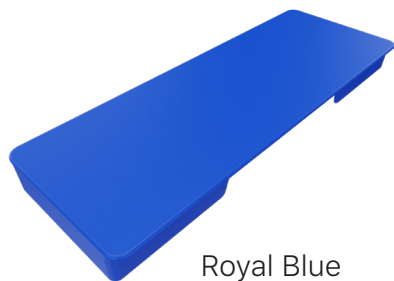

Royal Blue

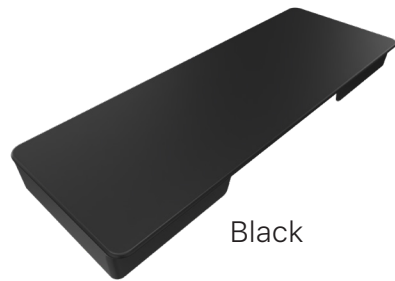

Black



Night Grey



en core groove

Easy clip in pen tray

The en core groove is an optional extra that allows a stylish push in tray for pen/pencil storage.



space

Recess pen grooves on the top of the legs helps to maximise your work area.



colours

Available in 10 brilliant colours to compliment the en one chair.

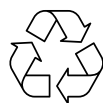

100% recyclable

Manufactured in the UK out of polypropylene, it is 100% recyclable at end of life.

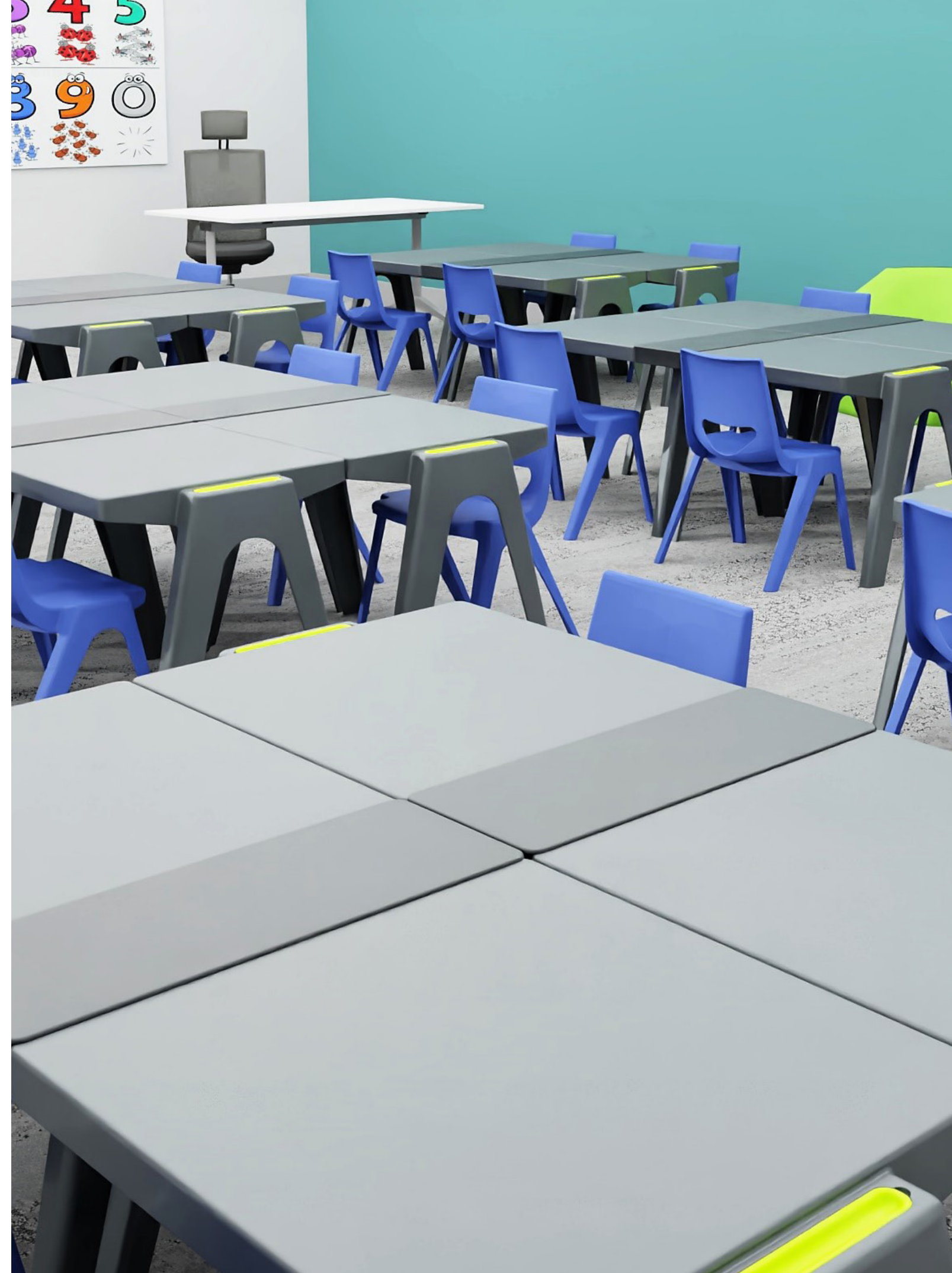
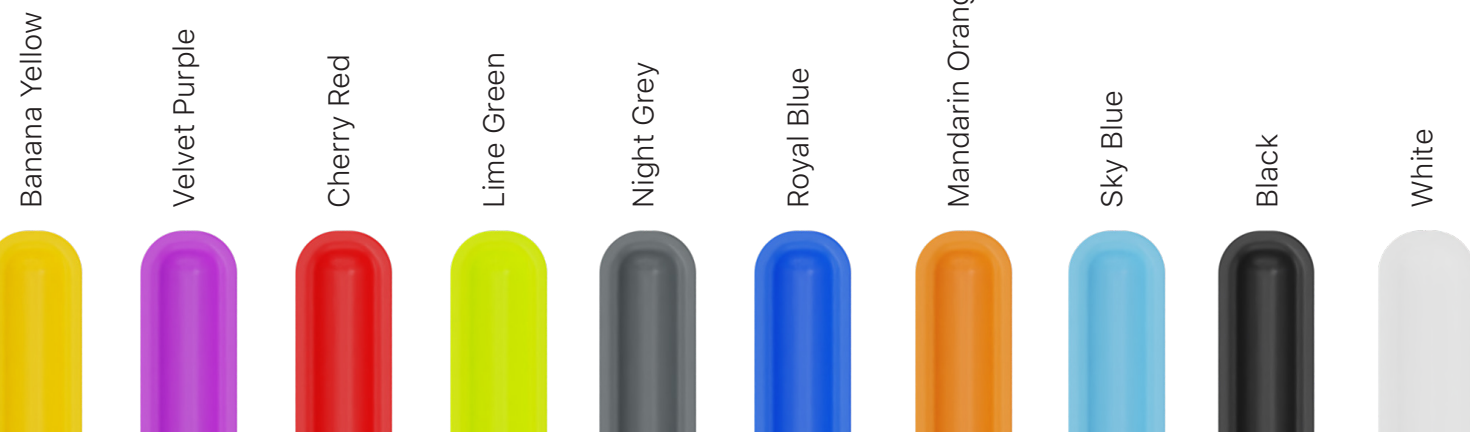

efficient stacking

Perfect storage solution

The en core table is designed to stack easily in a safe and secure manner. Areas can quickly be cleared to enable spaces to be configured into multiple learning environments.

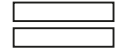

stacking

The en core stacks safely on a single dolly allowing them to be easily maneuvered.

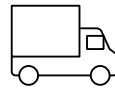

transport

With its efficient stacking, the en core can be packed on less pallets compared to traditional tables. Saving costs, fuel and providing an environmental benefit in transportation worldwide

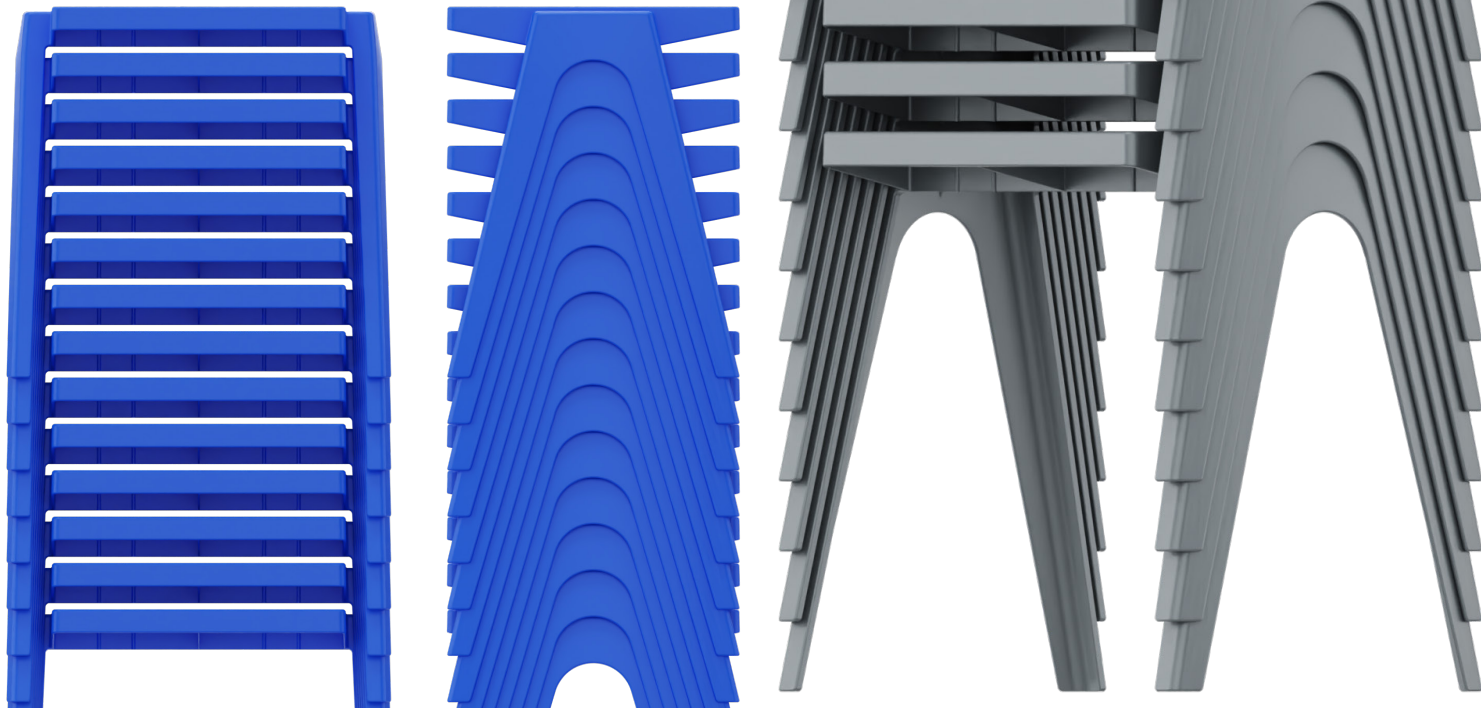

en core tray

Extra storage

Personal storage is easily catered for with the addition of a slide out plastic tray. Suitable for both A4 and A3 Gratnell's trays.

*Please note: en core table cannot be stacked when tray option is selected

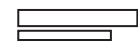

storage

Runners can be attached easily to the underside of the table as an optional extra.

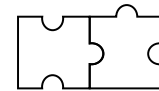

compatible

Designed to be suitable for Gratnell tray units to maximise space and storage solutions

product specifications

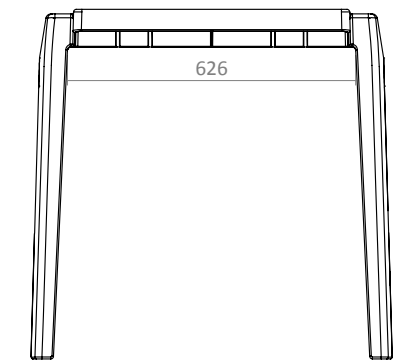
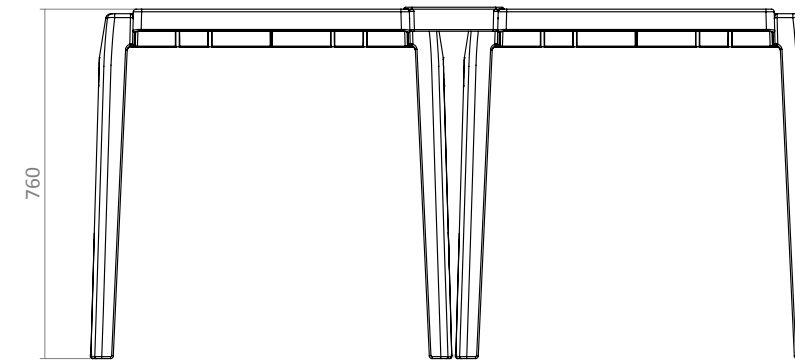
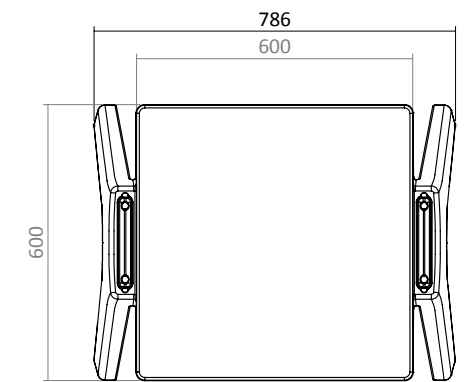
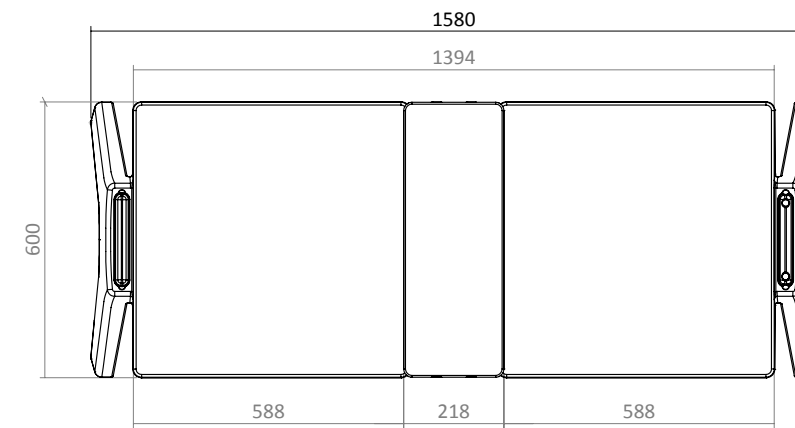

en core dimensions

code	description	overall height	overall width	width	depth	weight	leg distance
EN-CT1	Table size 1	460mm	768mm	600mm	600mm	5.1kg	626mm
EN-CT2	Table size 2	530mm	772mm	600mm	600mm	5.3kg	626mm
EN-CT3	Table size 3	590mm	776mm	600mm	600mm	5.5kg	626mm
EN-CT4	Table size 4	640mm	778mm	600mm	600mm	5.7kg	626mm
EN-CT5	Table size 5	710mm	782mm	600mm	600mm	5.8kg	626mm
EN-CT6	Table size 6	760mm	786mm	600mm	600mm	6kg	626mm
EN-CTPG	groove	37mm	32mm			0.02kg	
EN-CTCON	connected	48mm	218mm		598mm	1kg	
EN-CTDOL	en core table dolly, for storage and transport						
EN-CTTRA4	en core tray runners & Gratnells A4 tray						
EN-CTTRA3	en core tray runners & Gratnells A3 tray						

en core table colours



en core groove colours

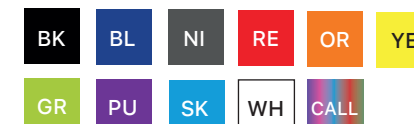

en core connected colours







▶ Head Office: Southern Depot

▶ Marsh Road | Lords Meadow Trading Estate | Crediton | Devon | EX17 1EU
Sales: Tel:01363 775411 | Fax: 01363 772467

▶ Northern Depot

Unit 4 Heathfield Business Park | Heathfield Street | Elland Halifax | Yorkshire | HX5 9AE
Sales: Tel:01422 311276 | Fax:01422 311278

▶ www.universalofficesolutions.co.uk ▶ Email: sales@uosltd.co.uk